

34-135 V
Continuous Input

5-48 V
Outputs

240 W
Max Power

3000 Vdc
Reinforced Insulation

Half-brick
DC-DC Converter



The InQor® Half-brick converter series is composed of next-generation, board-mountable, isolated, fixed switching frequency dc-dc converters that use synchronous rectification to achieve extremely high power conversion efficiency. Each module is supplied completely encased to provide protection from the harsh environments seen in many industrial and transportation applications.



Operational Features

- High efficiency, up to 91% at full rated load current
- Delivers full power with minimal derating
- Operating input voltage range: 34-135 V
- Fixed frequency switching provides predictable EMI
- No minimum load requirement

Mechanical Features

- Industry standard Half-brick pin-out
- Size: 2.386" x 2.486" x 0.512" (60.60 x 63.14 x 13.00 mm)
- Total weight: 4.7 oz (133 g)
- Flanged baseplate version available

Control Features

- On/Off control referenced to input side
- Remote sense for improved output voltage control
- Wide output voltage trim range

Safety Features

Reinforced Insulation

- UL 60950-1
- CAN/CSA C22.2 No. 60950-1
- EN 60950-1
- CE Marked
- RoHS compliant (see last page)

Protection Features

- Input under-voltage lockout
- Output current limit and short circuit protection
- Active back drive current limit
- Output over-voltage protection
- Thermal shutdown

CONTENTS

	Page No.
Family Electrical Characteristics	2
5Vout Electrical Characteristics & Figures	4
12Vout Electrical Characteristics & Figures	6
15Vout Electrical Characteristics & Figures	8
24Vout Electrical Characteristics & Figures	10
28Vout Electrical Characteristics & Figures	12
48Vout Electrical Characteristics & Figures	14
Application Section	16
Standards & Qualification Testing	20
Standard Mechanical Diagram	21
Flanged Mechanical Diagram	22
Ordering Information	23

IQ70 Family Electrical Characteristics (all output voltages)

Ta = 25 °C, airflow rate = 300 LFM, Vin = 70 Vdc unless otherwise noted; full operating temperature range is -40 °C to +100 °C baseplate temperature with appropriate power derating. Specifications subject to change without notice.

Parameter	Min.	Typ.	Max.	Units	Notes & Conditions
ABSOLUTE MAXIMUM RATINGS					
Input Voltage					
Non-Operating			150	V	Continuous
Operating			135	V	Continuous
Operating Transient			-	V	
Isolation Voltage					
Input to Output			3000	Vdc	
Input to Baseplate			3000	Vdc	
Output to Baseplate			3000	Vdc	
Operating Temperature	-40		100	°C	Baseplate temperature
Storage Temperature	-45		125	°C	
Voltage at ON/OFF input pin	-2		18	V	
INPUT CHARACTERISTICS					
Operating Input Voltage Range	34	70	135	V	
Input Under-Voltage Lockout					
Turn-On Voltage Threshold	32.7	33.1	33.5	V	
Turn-Off Voltage Threshold	30.4	30.8	31.2	V	
Lockout Voltage Hysteresis		2.3		V	
Input Over-Voltage Shutdown		-		V	
Recommended External Input Capacitance		100		µF	Typical ESR 0.1-0.2 Ω; see Note 2
Input Filter Component Values (L\C)		3.4\4.0		µH\µF	Internal values; see Figure D
DYNAMIC CHARACTERISTICS					
Turn-On Transient					
Turn-On Time		10		ms	Full load, Vout = 90 % nom. (from enable)
Start-Up Inhibit Time	180	200	220	ms	Figure E
Output Voltage Overshoot		0		%	Maximum Output Capacitance
ISOLATION CHARACTERISTICS					
Isolation Voltage (dielectric strength)					See Absolute Maximum Ratings
Isolation Resistance		30		MΩ	
Isolation Capacitance (input to output)		1000		pF	See Note 1
TEMPERATURE LIMITS FOR POWER DERATING CURVES					
Semiconductor Junction Temperature			125	°C	Package rated to 150 °C
PCB Temperature			125	°C	UL rated max operating temp 130 °C
Transformer Temperature			125	°C	
Maximum Baseplate Temperature, Tb			100	°C	
FEATURE CHARACTERISTICS					
Switching Frequency	255	275	295	kHz	Isolation stage switching freq. is half this
ON/OFF Control					
Off-State Voltage	2.4		18	V	
On-State Voltage	-2		0.8	V	
ON/OFF Control					
Pull-Up Voltage		5		V	Application notes Figures A & B
Pull-Up Resistance		50		kΩ	
Over-Temperature Shutdown OTP Trip Point		125		°C	Average PCB Temperature
Over-Temperature Shutdown Restart Hysteresis		10		°C	
RELIABILITY CHARACTERISTICS					
Calculated MTBF (Telcordia) TR-NWT-000332		1.44		10 ⁶ Hrs.	Tb = 70 °C
Calculated MTBF (MIL-217) MIL-HDBK-217F		1.20		10 ⁶ Hrs.	Tb = 70 °C

Note 1: Higher values of isolation capacitance can be added externally to the module.

Note 2: See "Input System Instability" in the Application Considerations section.

Family Figures (all output voltages)

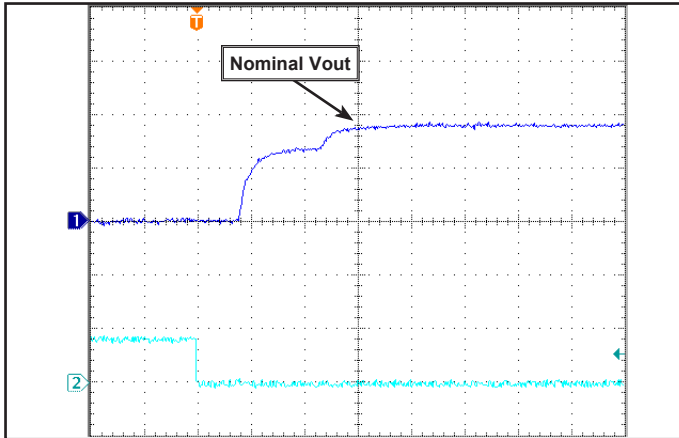

Common Figure 1: Typical startup waveform. Input voltage pre-applied, ON/OFF Pin on Ch 2.

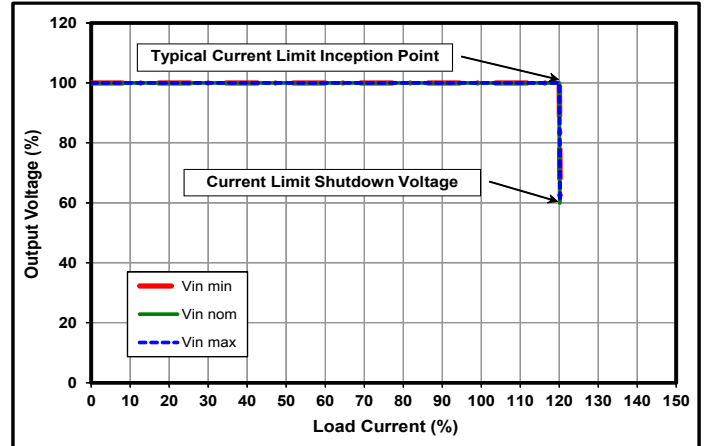

Common Figure 2: Output voltage vs. load current showing typical current limit curves and converter shutdown points.

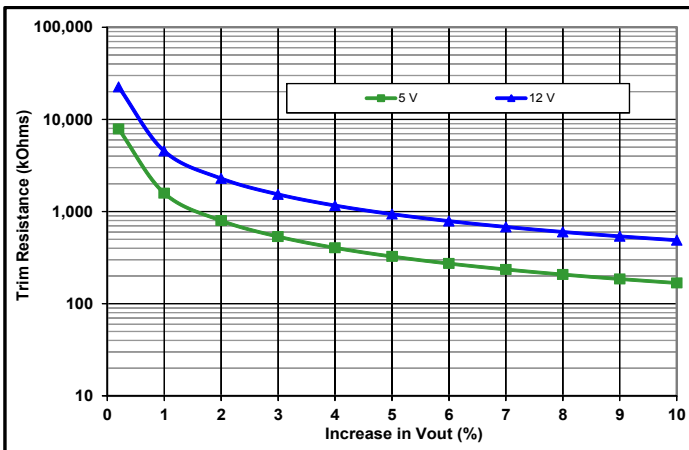

Common Figure 3: Trim graph for trim-up 5 to 12 V outputs.

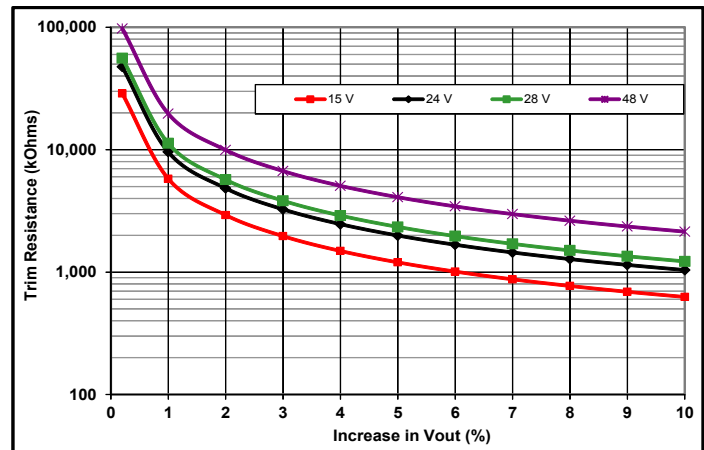

Common Figure 4: Trim graph for trim-up 15 to 48 V outputs.

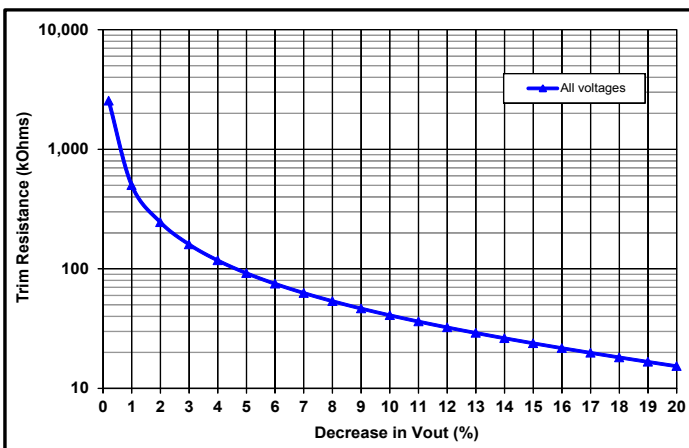

Common Figure 5: Trim graph for trim down.

IQ70050HPx44 Electrical Characteristics (5.0 Vout)

Ta = 25 °C, airflow rate = 300 LFM, Vin = 70 Vdc unless otherwise noted; full operating temperature range is -40 °C to +100 °C baseplate temperature with appropriate power derating. Specifications subject to change without notice.

Parameter	Min.	Typ.	Max.	Units	Notes & Conditions
INPUT CHARACTERISTICS					
Maximum Input Current			9.0	A	Vin min; 5 Vout ; in current limit (typ)
No-Load Input Current (enabled)		100	130	mA	
Disabled Input Current		2	4	mA	
Response to Input Transient		0.35		V	500 V/ms, see Figure 6
Input Terminal Ripple Current		400		mA	RMS
Recommended Input Fuse			15	A	Fast acting fuse recommended, see Note 3
OUTPUT CHARACTERISTICS					
Output Voltage Set Point	4.950	5.000	5.050	V	
Output Voltage Regulation					
Over Line		±0.1	±0.3	%	
Over Load		±0.1	±0.3	%	
Over Temperature	-75		75	mV	
Total Output Voltage Range	4.875		5.125	V	Over sample, line, load, temperature & life
Output Voltage Ripple and Noise					20 MHz bandwidth; see Note 1
Peak-to-Peak		170	340	mV	Full load
RMS		25	50	mV	Full load
Operating Output Current Range	0		44	A	Subject to thermal derating
Output DC Current Limit Inception	48.4	52.8	57.2	A	Output voltage 10 % Low
Output DC Current Limit Shutdown Voltage		2.7		V	
Back-Drive Current Limit while Enabled		0.55		A	Negative current drawn into output pins
Back-Drive Current Limit while Disabled		1		mA	Negative current drawn into output pins
Maximum Output Capacitance			8,000	µF	Vout nominal at full load (resistive load)
Output Voltage during Load Current Transient					
Step Change in Output Current (0.2 A/µs)		210		mV	50 % to 75 % to 50 % Iout max; see Figure 5
Settling Time		400		µs	To within 1 % Vout nom; see Figure 5
Output Voltage Trim Range	-20		10	%	Across Pins 8 & 4; Common Figures 3-5; See Note 2
Output Voltage Remote Sense Range			10	%	Across Pins 8 & 4
Output Over-Voltage Protection	5.9	6.1	6.4	V	Over full temp range
EFFICIENCY					
100 % Load		87		%	See Figure 1 for efficiency curve
50 % Load		90		%	See Figure 1 for efficiency curve

Note 1: Output is terminated with 1 µF ceramic and 15 µF low-ESR tantalum capacitors. For applications requiring reduced output voltage ripple and noise, consult SynQor applications support (e-mail: support@synqor.com)

Note 2: Trim-up range is limited below 10 % at low line and full load.

Note 3: Safety certification requires the use of a fuse rated at or below this value.

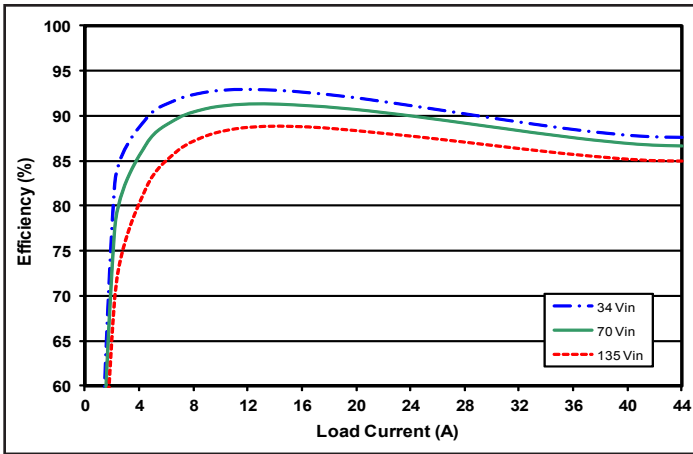

Figure 1: Efficiency at nominal output voltage vs. load current for minimum, nominal, and maximum input voltage at 25 °C.

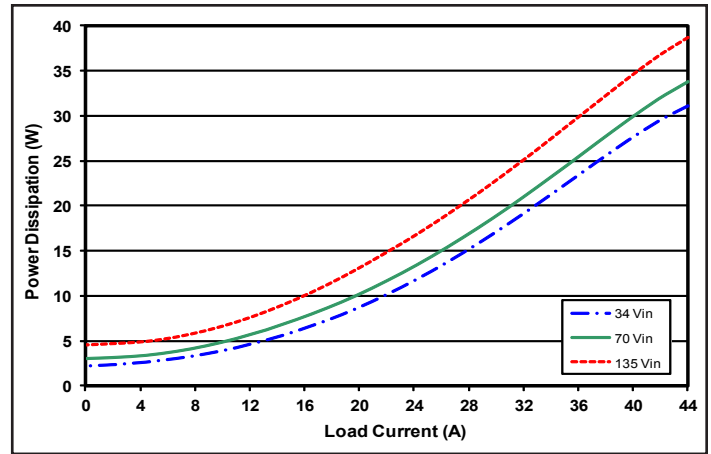

Figure 2: Power dissipation at nominal output voltage vs. load current for minimum, nominal, and maximum input voltage at 25 °C.

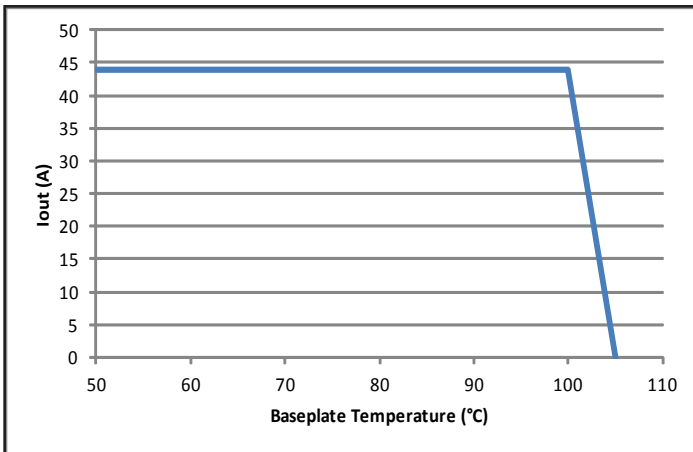

Figure 3: Maximum load current vs. baseplate temperature when conductively cooled. Note: The system design must provide a suitable thermal path that maintains the baseplate temperature below 100 °C.

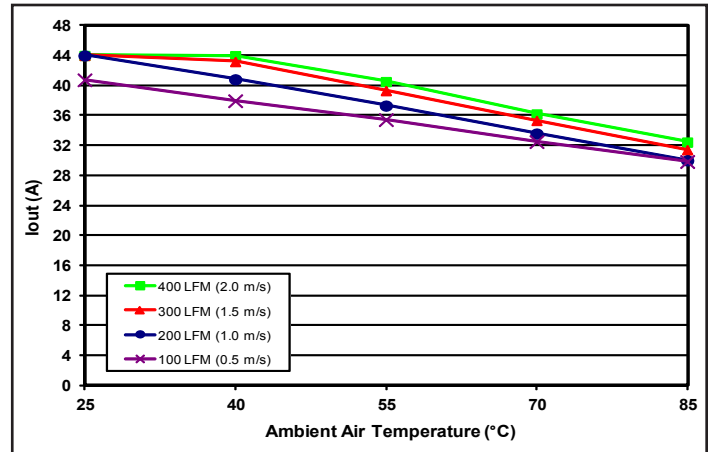

Figure 4: Encased converter (with 1/2" heatsink) max. output power derating vs. ambient air temperature for airflow rates of 100 LFM through 400 LFM. Air flows across the converter from input to output (nominal input voltage).

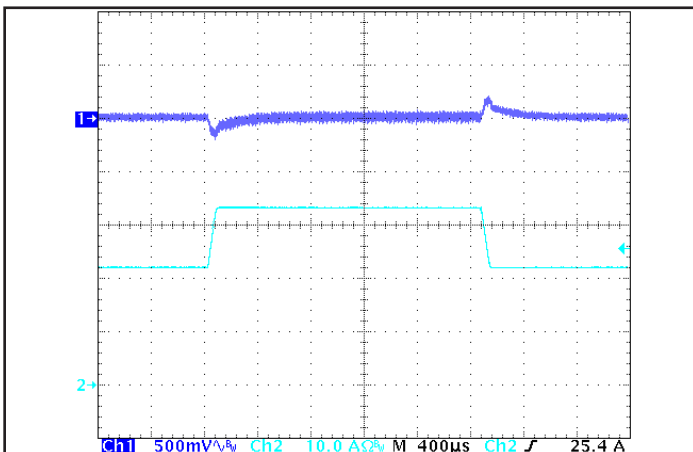

Figure 5: Output voltage response to step-change in load current (50% -75% -50% of I_{out}(max); dI/dt = 0.2 A/μs). Load cap: 15μF tantalum and 1μF ceramic capacitors. Ch 1: V_{out}, Ch 2: I_{out}.

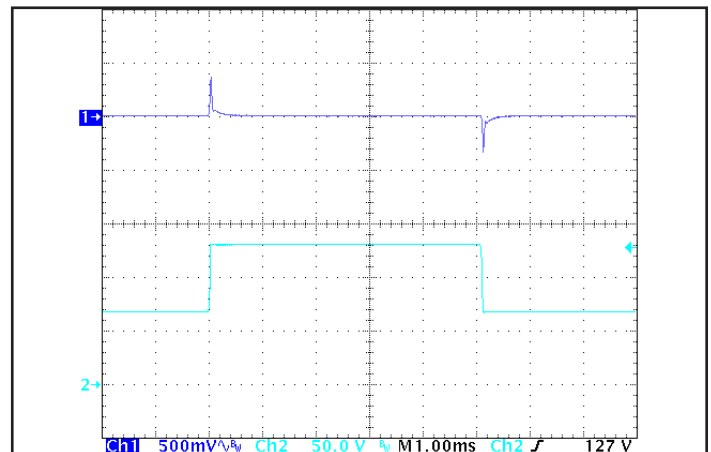

Figure 6: Output voltage response to step-change in input voltage (nominal to maximum, 250 V/ms). Load cap: 15 μF tantalum and 1 μF ceramic capacitors. Ch 1: V_{out}, Ch 2: V_{in}.

IQ70120HPx20 Electrical Characteristics (12 Vout)

Ta = 25 °C, airflow rate = 300 LFM, Vin = 70 Vdc unless otherwise noted; full operating temperature range is -40 °C to +100 °C baseplate temperature with appropriate power derating. Specifications subject to change without notice.

Parameter	Min.	Typ.	Max.	Units	Notes & Conditions
INPUT CHARACTERISTICS					
Maximum Input Current			9.3	A	Vin min; 12 Vout ; in current limit (typ)
No-Load Input Current (enabled)		100	130	mA	
Disabled Input Current		2	4	mA	
Response to Input Transient		0.75		V	500 V/ms, see Figure 6
Input Terminal Ripple Current		400		mA	RMS
Recommended Input Fuse			15	A	Fast acting fuse recommended, see Note 3
OUTPUT CHARACTERISTICS					
Output Voltage Set Point	11.88	12.00	12.12	V	
Output Voltage Regulation					
Over Line		±0.1	±0.3	%	
Over Load		±0.1	±0.3	%	
Over Temperature	-180		180	mV	
Total Output Voltage Range	11.70		12.30	V	Over sample, line, load, temperature & life
Output Voltage Ripple and Noise					20 MHz bandwidth; see Note 1
Peak-to-Peak		100	200	mV	Full load
RMS		25	50	mV	Full load
Operating Output Current Range	0		20	A	Subject to thermal derating
Output DC Current Limit Inception	22.0	24.0	26.0	A	Output voltage 10 % Low
Output DC Current Limit Shutdown Voltage		6.5		V	
Back-Drive Current Limit while Enabled		0.5		A	Negative current drawn into output pins
Back-Drive Current Limit while Disabled		1		mA	Negative current drawn into output pins
Maximum Output Capacitance			1,500	µF	Vout nominal at full load (resistive load)
Output Voltage during Load Current Transient					
Step Change in Output Current (0.2 A/µs)		270		mV	50 % to 75 % to 50 % Iout max; see Figure 5
Settling Time		400		µs	To within 1 % Vout nom; see Figure 5
Output Voltage Trim Range	-20		10	%	Across Pins 8 & 4; Common Figures 3-5; see Note 2
Output Voltage Remote Sense Range			10	%	Across Pins 8 & 4
Output Over-Voltage Protection	14.0	14.6	15.3	V	Over full temp range
EFFICIENCY					
100 % Load		91		%	See Figure 1 for efficiency curve
50 % Load		93		%	See Figure 1 for efficiency curve

Note 1: Output is terminated with 1 µF ceramic and 15 µF low-ESR tantalum capacitors. For applications requiring reduced output voltage ripple and noise, consult SynQor applications support (e-mail: support@synqor.com)

Note 2: Trim-up range is limited below 10 % at low line and full load.

Note 3: Safety certification requires the use of a fuse rated at or below this value.

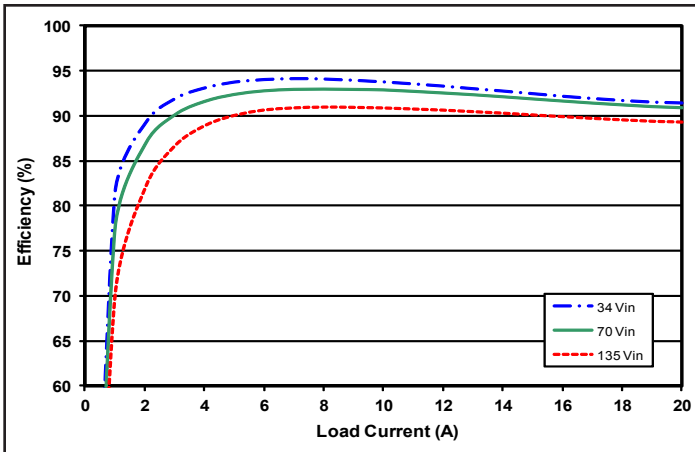

Figure 1: Efficiency at nominal output voltage vs. load current for minimum, nominal, and maximum input voltage at 25 °C.

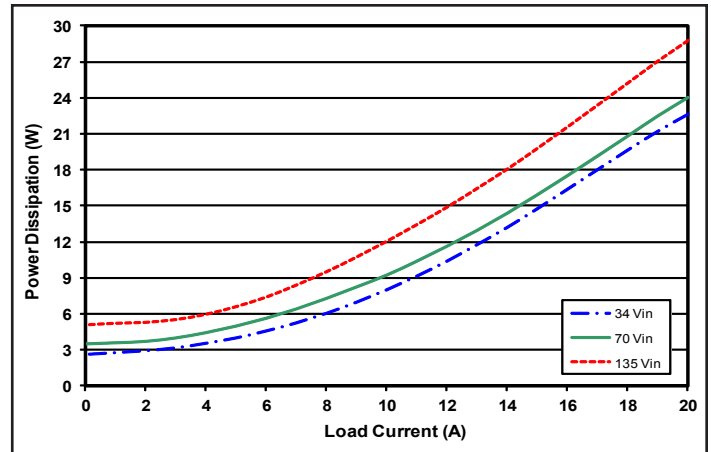

Figure 2: Power dissipation at nominal output voltage vs. load current for minimum, nominal, and maximum input voltage at 25 °C.

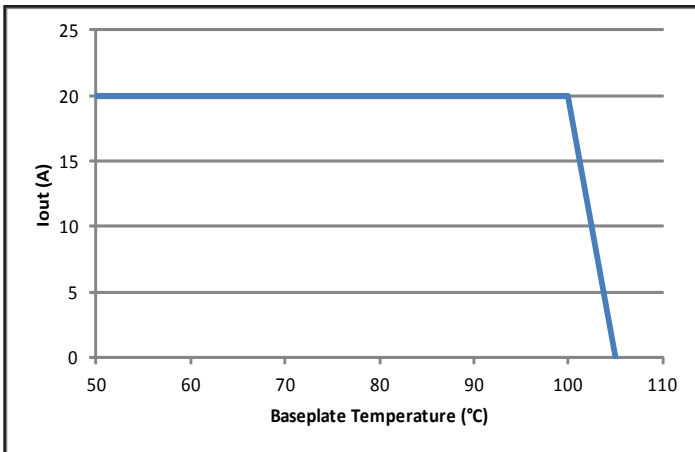

Figure 3: Maximum load current vs. baseplate temperature when conductively cooled. Note: The system design must provide a suitable thermal path that maintains the baseplate temperature below 100 °C.

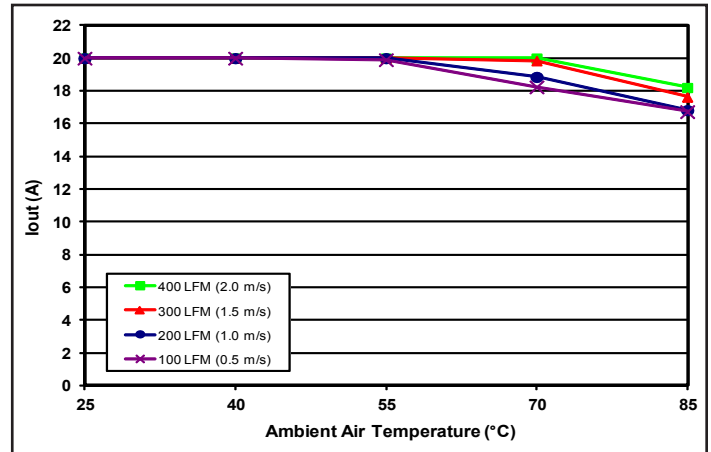

Figure 4: Encased converter (with 1/2" heatsink) max. output power derating vs. ambient air temperature for airflow rates of 100 LFM through 400 LFM. Air flows across the converter from input to output (nominal input voltage).

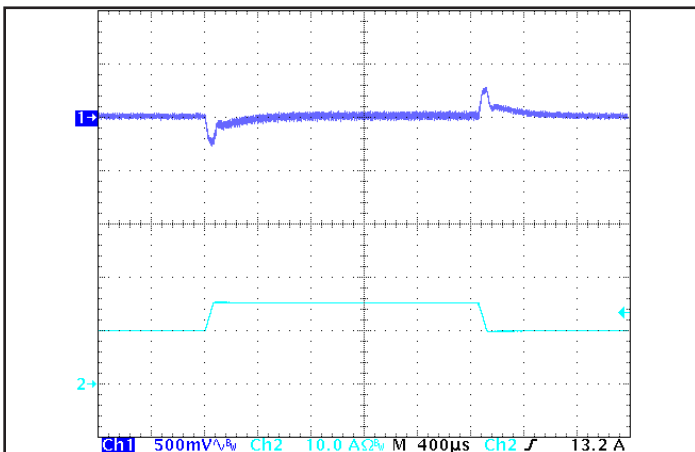

Figure 5: Output voltage response to step-change in load current (50% -75% -50% of Iout(max); dI/dt = 0.2 A/μs). Load cap: 15 μF tantalum and 1 uF ceramic capacitors. Ch 1: Vout, Ch 2: Iout.

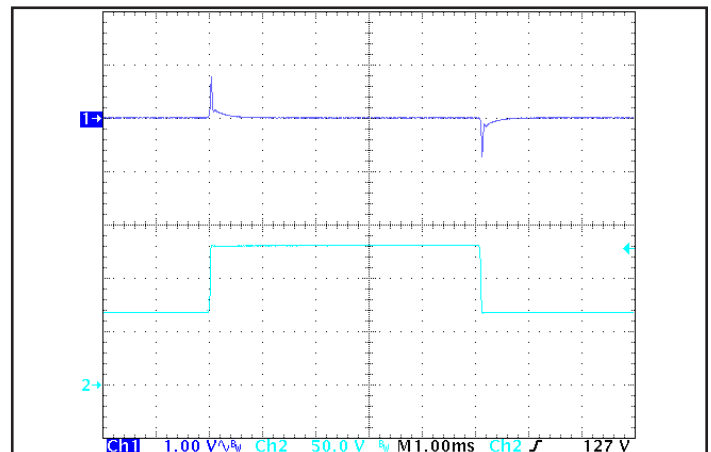

Figure 6: Output voltage response to step-change in input voltage (nominal to maximum, 250 V/ms). Load cap: 15 μF tantalum and 1 uF ceramic capacitors. Ch 1: Vout, Ch 2: Vin.

IQ70150HPx16 Electrical Characteristics (15 Vout)

Ta = 25 °C, airflow rate = 300 LFM, Vin = 70 Vdc unless otherwise noted; full operating temperature range is -40 °C to +100 °C baseplate temperature with appropriate power derating. Specifications subject to change without notice.

Parameter	Min.	Typ.	Max.	Units	Notes & Conditions
INPUT CHARACTERISTICS					
Maximum Input Current			9.4	A	Vin min; 15 Vout ; in current limit (typ)
No-Load Input Current (enabled)		100	130	mA	
Disabled Input Current		2	4	mA	
Response to Input Transient		0.9		V	500 V/ms, see Figure 6
Input Terminal Ripple Current		400		mA	RMS
Recommended Input Fuse			15	A	Fast acting fuse recommended, see Note 3
OUTPUT CHARACTERISTICS					
Output Voltage Set Point	14.85	15.00	15.15	V	
Output Voltage Regulation					
Over Line		±0.1	±0.3	%	
Over Load		±0.1	±0.3	%	
Over Temperature	-225		225	mV	
Total Output Voltage Range	14.62		15.38	V	Over sample, line, load, temperature & life
Output Voltage Ripple and Noise					20 MHz bandwidth; see Note 1
Peak-to-Peak		130	260	mV	Full load
RMS		25	50	mV	Full load
Operating Output Current Range	0		16	A	Subject to thermal derating
Output DC Current Limit Inception	17.6	19.2	20.8	A	Output voltage 10 % Low
Output DC Current Limit Shutdown Voltage		8.5		V	
Back-Drive Current Limit while Enabled		0.35		A	Negative current drawn into output pins
Back-Drive Current Limit while Disabled		1		mA	Negative current drawn into output pins
Maximum Output Capacitance			1,000	µF	Vout nominal at full load (resistive load)
Output Voltage during Load Current Transient					
Step Change in Output Current (0.2 A/µs)		500		mV	50 % to 75 % to 50 % Iout max; see Figure 5
Settling Time		400		µs	To within 1 % Vout nom; see Figure 5
Output Voltage Trim Range	-20		10	%	Across Pins 8 & 4; Common Figures 3-5; see Note 2
Output Voltage Remote Sense Range			10	%	Across Pins 8 & 4
Output Over-Voltage Protection	17.6	18.3	19.1	V	Over full temp range
EFFICIENCY					
100 % Load		90		%	See Figure 1 for efficiency curve
50 % Load		93		%	See Figure 1 for efficiency curve

Note 1: Output is terminated with 1 µF ceramic and 15 µF low-ESR tantalum capacitors. For applications requiring reduced output voltage ripple and noise, consult SynQor applications support (e-mail: support@synqor.com)

Note 2: Trim-up range is limited below 10% at low line and full load.

Note 3: Safety certification requires the use of a fuse rated at or below this value.

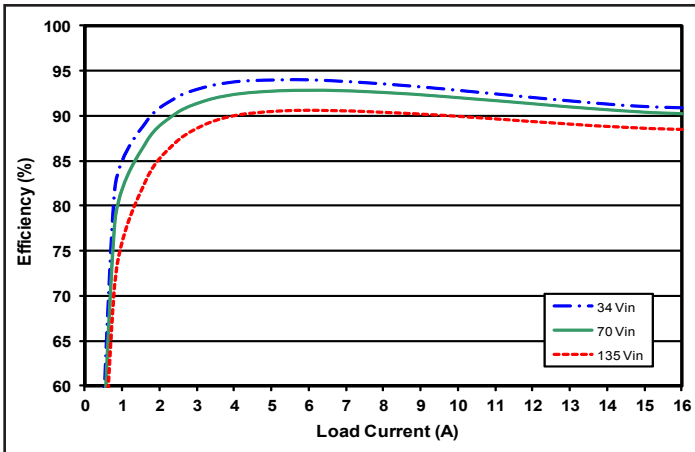

Figure 1: Efficiency at nominal output voltage vs. load current for minimum, nominal, and maximum input voltage at 25 °C.

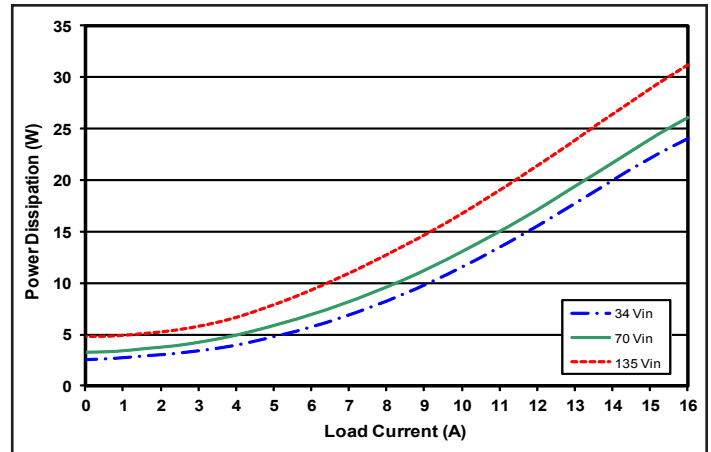

Figure 2: Power dissipation at nominal output voltage vs. load current for minimum, nominal, and maximum input voltage at 25 °C.

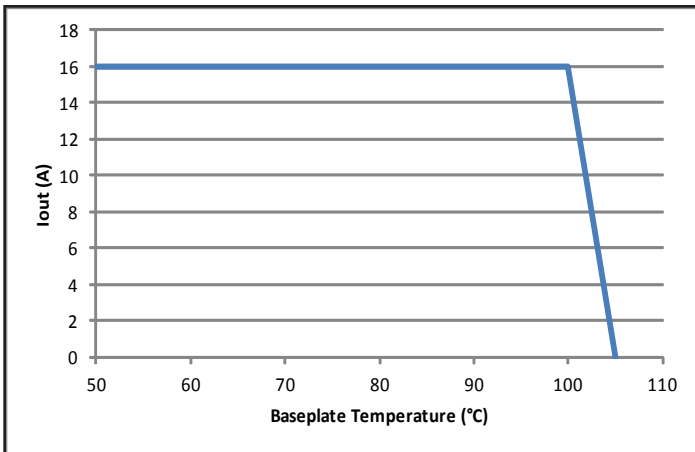

Figure 3: Maximum load current vs. baseplate temperature when conductively cooled. Note: The system design must provide a suitable thermal path that maintains the baseplate temperature below 100 °C.

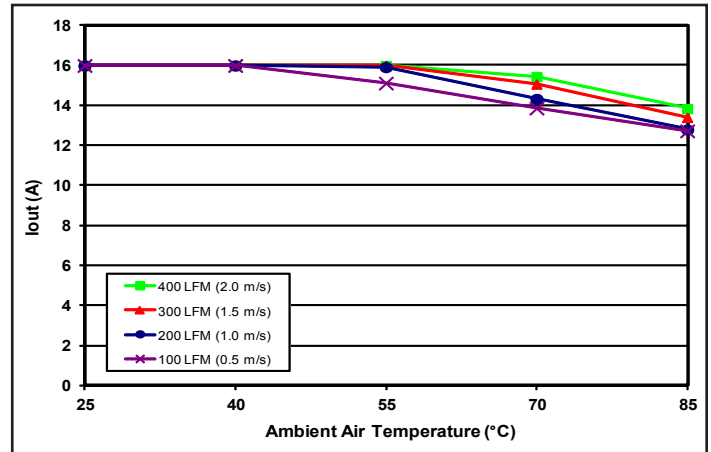

Figure 4: Encased converter (with 1/2" heatsink) max. output power derating vs. ambient air temperature for airflow rates of 100 LFM through 400 LFM. Air flows across the converter from input to output (nominal input voltage).

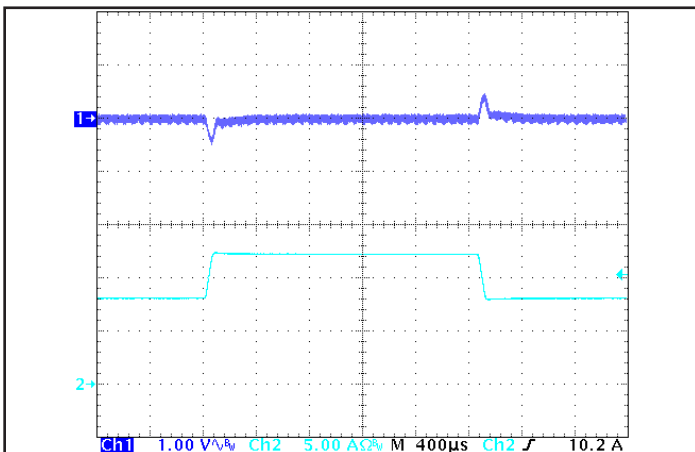

Figure 5: Output voltage response to step-change in load current (50% -75% -50% of I_{out}(max); dI/dt = 0.2 A/μs). Load cap: 1 μF ceramic capacitor. Ch 1: V_{out}, Ch 2: I_{out}.

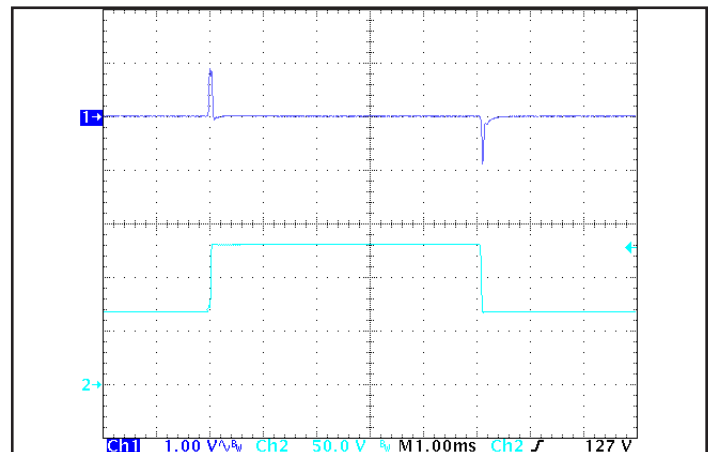

Figure 6: Output voltage response to step-change in input voltage (nominal to maximum, 250 V/ms). Load cap: 1 μF ceramic capacitor. Ch 1: V_{out}, Ch 2: V_{in}.

IQ70240HPx10 Electrical Characteristics (24 Vout)

Ta = 25 °C, airflow rate = 300 LFM, Vin = 70 Vdc unless otherwise noted; full operating temperature range is -40 °C to +100 °C baseplate temperature with appropriate power derating. Specifications subject to change without notice.

Parameter	Min.	Typ.	Max.	Units	Notes & Conditions
INPUT CHARACTERISTICS					
Maximum Input Current			10.5	A	Vin min; trim-up ; in current limit (typ)
No-Load Input Current (enabled)		100	130	mA	
Disabled Input Current		2	4	mA	
Response to Input Transient		1.7		V	500 V/ms, see Figure 6
Input Terminal Ripple Current		400		mA	RMS
Recommended Input Fuse			15	A	Fast acting fuse recommended, see Note 3
OUTPUT CHARACTERISTICS					
Output Voltage Set Point	23.76	24.00	24.24	V	
Output Voltage Regulation					
Over Line		±0.1	±0.3	%	
Over Load		±0.1	±0.3	%	
Over Temperature	-360		360	mV	
Total Output Voltage Range	23.40		24.60	V	Over sample, line, load, temperature & life
Output Voltage Ripple and Noise					20 MHz bandwidth; see Note 1
Peak-to-Peak		200	400	mV	Full load
RMS		35	70	mV	Full load
Operating Output Current Range	0		10	A	Subject to thermal derating
Output DC Current Limit Inception	11.0	12.0	13.0	A	Output voltage 10 % Low
Output DC Current Limit Shutdown Voltage		15		V	
Back-Drive Current Limit while Enabled		0.15		A	Negative current drawn into output pins
Back-Drive Current Limit while Disabled		1		mA	Negative current drawn into output pins
Maximum Output Capacitance			400	µF	Vout nominal at full load (resistive load)
Output Voltage during Load Current Transient					
Step Change in Output Current (0.2 A/µs)		1300		mV	50 % to 75 % to 50 % Iout max; see Figure 5
Settling Time		400		µs	To within 1 % Vout nom; see Figure 5
Output Voltage Trim Range	-20		10	%	Across Pins 8 & 4; Common Figures 3-5
Output Voltage Remote Sense Range			10	%	Across Pins 8 & 4
Output Over-Voltage Protection	28.1	29.3	30.5	V	Over full temp range
EFFICIENCY					
100 % Load		88		%	See Figure 1 for efficiency curve
50 % Load		92		%	See Figure 1 for efficiency curve

Note 1: Output is terminated with 1 µF ceramic and 15 µF low-ESR tantalum capacitors. For applications requiring reduced output voltage ripple and noise, consult SynQor applications support (e-mail: support@synqor.com)

Note 2: Trim-up range is limited below 10 % at low line and full load.

Note 3: Safety certification requires the use of a fuse rated at or below this value.

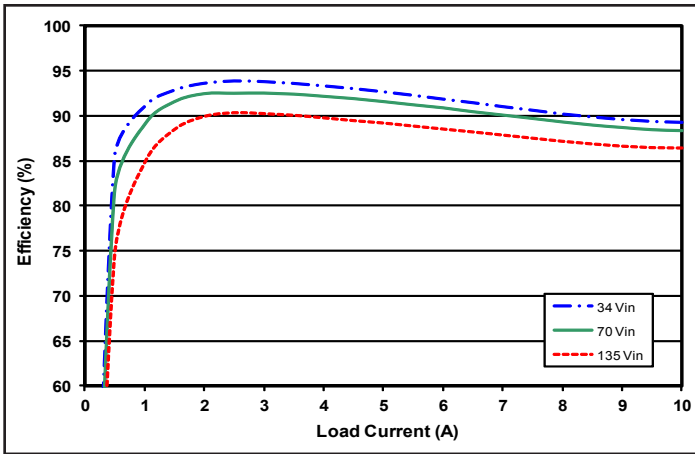

Figure 1: Efficiency at nominal output voltage vs. load current for minimum, nominal, and maximum input voltage at 25 °C.

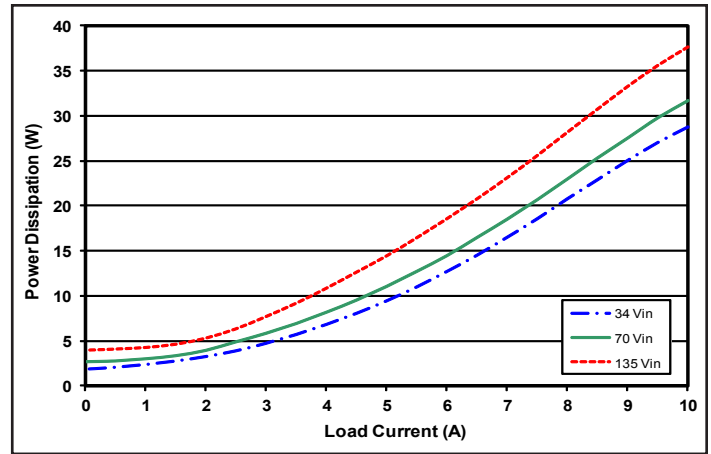

Figure 2: Power dissipation at nominal output voltage vs. load current for minimum, nominal, and maximum input voltage at 25 °C.

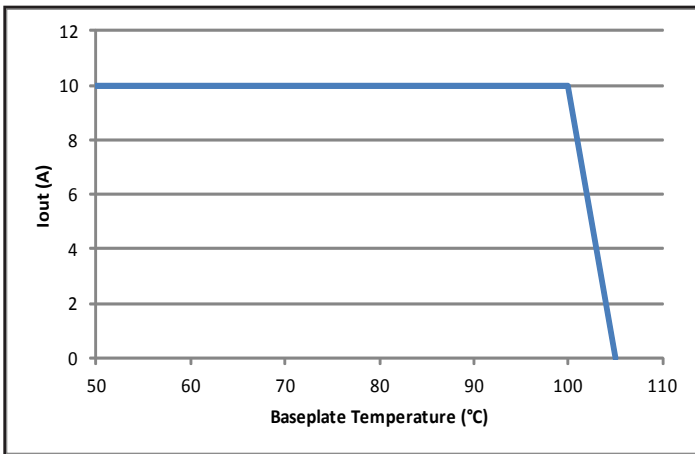

Figure 3: Maximum load current vs. baseplate temperature when conductively cooled. Note: The system design must provide a suitable thermal path that maintains the baseplate temperature below 100 °C.

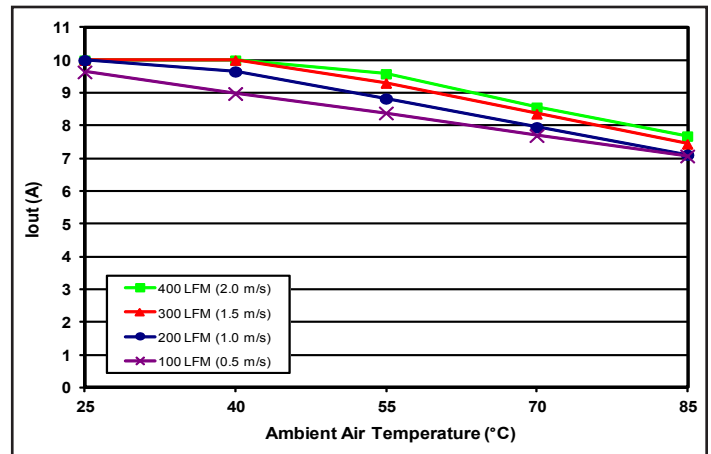

Figure 4: Encased converter (with 1/2" heatsink) max. output power derating vs. ambient air temperature for airflow rates of 100 LFM through 400 LFM. Air flows across the converter from input to output (nominal input voltage).

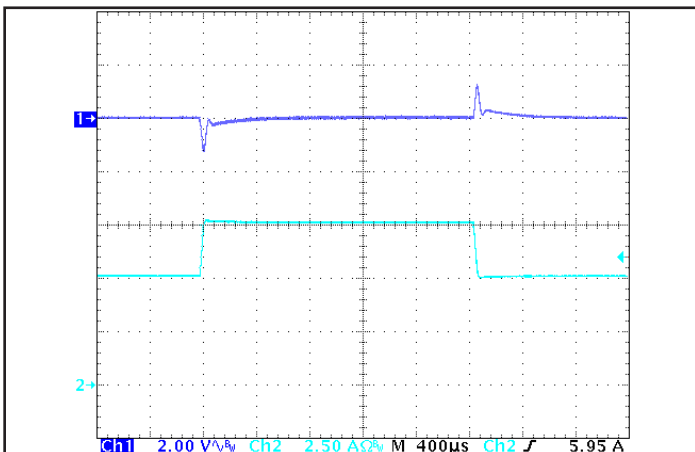

Figure 5: Output voltage response to step-change in load current (50% -75% -50% of I_{out}(max); dI/dt = 0.2 A/μs). Load cap: 1 μF ceramic capacitor. Ch 1: V_{out}, Ch 2: I_{out}.

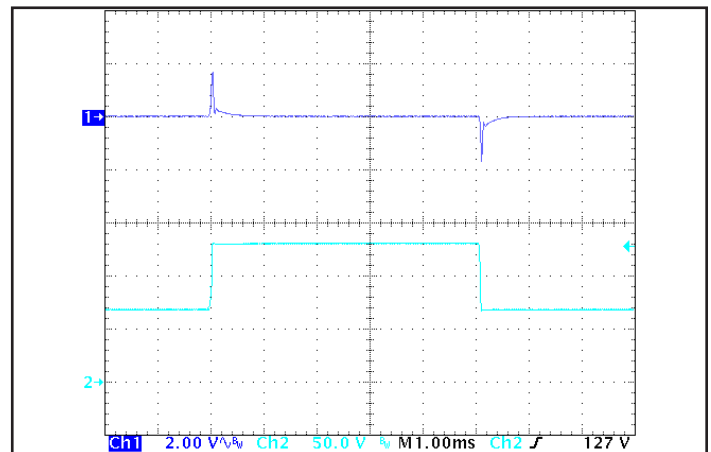

Figure 6: Output voltage response to step-change in input voltage (nominal to maximum, 250 V/ms). Load cap: 1 μF ceramic capacitor. Ch 1: V_{out}, Ch 2: V_{in}.

IQ70280HPx8F Electrical Characteristics (28 Vout)

Ta = 25 °C, airflow rate = 300 LFM, Vin = 70 Vdc unless otherwise noted; full operating temperature range is -40 °C to +100 °C baseplate temperature with appropriate power derating. Specifications subject to change without notice.

Parameter	Min.	Typ.	Max.	Units	Notes & Conditions
INPUT CHARACTERISTICS					
Maximum Input Current			10.4	A	Vin min; trim-up ; in current limit (typ)
No-Load Input Current (enabled)		100	130	mA	
Disabled Input Current		2	4	mA	
Response to Input Transient		2		V	500 V/ms, see Figure 6
Input Terminal Ripple Current		400		mA	RMS
Recommended Input Fuse			15	A	Fast acting fuse recommended, see Note 3
OUTPUT CHARACTERISTICS					
Output Voltage Set Point	27.72	28.00	28.28	V	
Output Voltage Regulation					
Over Line		±0.1	±0.3	%	
Over Load		±0.1	±0.3	%	
Over Temperature	-420		420	mV	
Total Output Voltage Range	27.30		28.70	V	Over sample, line, load, temperature & life
Output Voltage Ripple and Noise					20 MHz bandwidth; see Note 1
Peak-to-Peak		230	460	mV	Full load
RMS		40	80	mV	Full load
Operating Output Current Range	0		8.5	A	Subject to thermal derating
Output DC Current Limit Inception	9.35	10.2	11.1	A	Output voltage 10 % Low
Output DC Current Limit Shutdown Voltage		17		V	
Back-Drive Current Limit while Enabled		0.17		A	Negative current drawn into output pins
Back-Drive Current Limit while Disabled		1		mA	Negative current drawn into output pins
Maximum Output Capacitance			250	µF	Vout nominal at full load (resistive load)
Output Voltage during Load Current Transient					
Step Change in Output Current (0.2 A/µs)		1500		mV	50 % to 75 % to 50 % Iout max; see Figure 5
Settling Time		400		µs	To within 1 % Vout nom; see Figure 5
Output Voltage Trim Range	-20		10	%	Across Pins 8 & 4; Common Figures 3-5
Output Voltage Remote Sense Range			10	%	Across Pins 8 & 4
Output Over-Voltage Protection	32.8	34.2	35.6	V	Over full temp range
EFFICIENCY					
100 % Load		89		%	See Figure 1 for efficiency curve
50 % Load		92		%	See Figure 1 for efficiency curve

Note 1: Output is terminated with 1 µF ceramic and 15 µF low-ESR tantalum capacitors. For applications requiring reduced output voltage ripple and noise, consult SynQor applications support (e-mail: support@synqor.com)

Note 3: Safety certification requires the use of a fuse rated at or below this value.

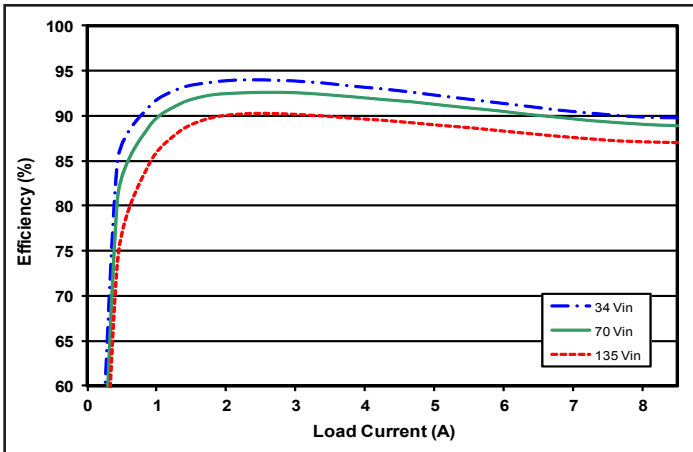

Figure 1: Efficiency at nominal output voltage vs. load current for minimum, nominal, and maximum input voltage at 25 °C.

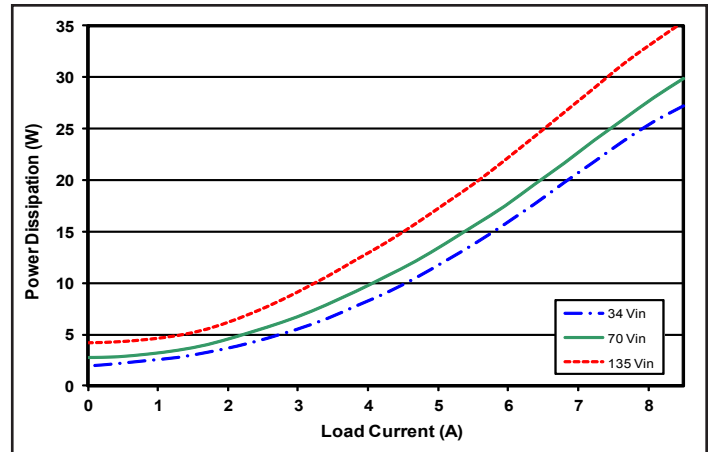

Figure 2: Power dissipation at nominal output voltage vs. load current for minimum, nominal, and maximum input voltage at 25 °C.

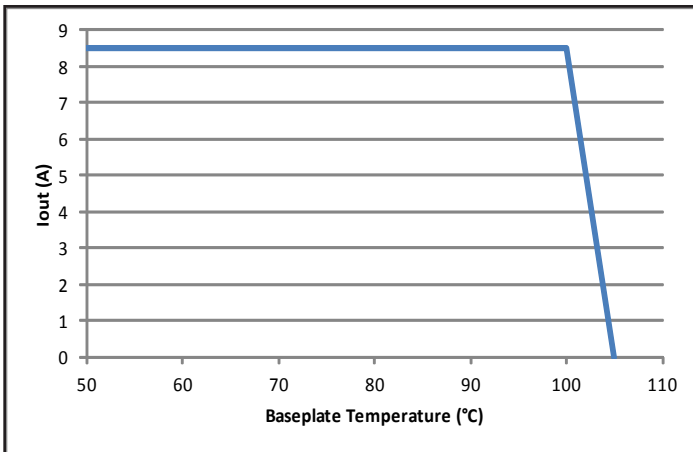

Figure 3: Maximum load current vs. baseplate temperature when conductively cooled. Note: The system design must provide a suitable thermal path that maintains the baseplate temperature below 100 °C.

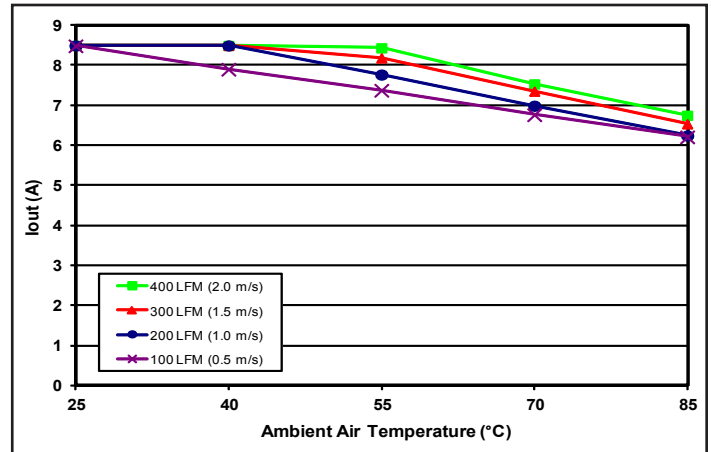

Figure 4: Encased converter (with 1/2" heatsink) max. output power derating vs. ambient air temperature for airflow rates of 100 LFM through 400 LFM. Air flows across the converter from input to output (nominal input voltage).

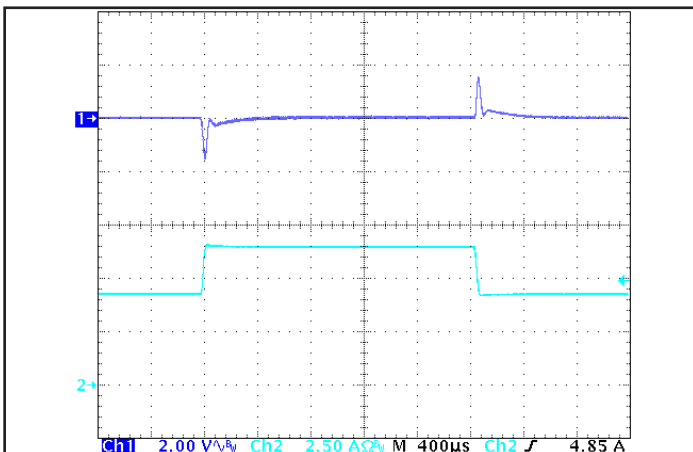

Figure 5: Output voltage response to step-change in load current (50% -75% -50% of I_{out}(max); dI/dt = 0.2 A/μs). Load cap: 1 μF ceramic capacitor. Ch 1: V_{out}, Ch 2: I_{out}.

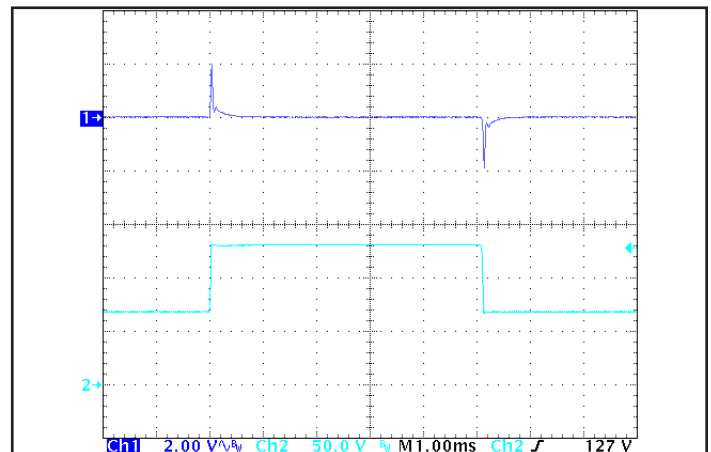

Figure 6: Output voltage response to step-change in input voltage (nominal to maximum, 250 V/ms). Load cap: 1 μF ceramic capacitor. Ch 1: V_{out}, Ch 2: V_{in}.



Technical Specification

Input: 34-135 V
Output: 48 V
Current: 5 A
Part No.: IQ70480HPx05

IQ70480HPx05 Electrical Characteristics (48 Vout)

Ta = 25 °C, airflow rate = 300 LFM, Vin = 70 Vdc unless otherwise noted; full operating temperature range is -40 °C to +100 °C baseplate temperature with appropriate power derating. Specifications subject to change without notice.

Parameter	Min.	Typ.	Max.	Units	Notes & Conditions
INPUT CHARACTERISTICS					
Maximum Input Current			10.4	A	Vin min; trim-up ; in current limit (typ)
No-Load Input Current (enabled)		100	130	mA	
Disabled Input Current		2	4	mA	
Response to Input Transient		3.2		V	500 V/ms, see Figure 6
Input Terminal Ripple Current		400		mA	RMS
Recommended Input Fuse			15	A	Fast acting fuse recommended, see Note 3
OUTPUT CHARACTERISTICS					
Output Voltage Set Point	47.52	48.00	48.48	V	
Output Voltage Regulation					
Over Line		±0.1	±0.3	%	
Over Load		±0.1	±0.3	%	
Over Temperature	-720		720	mV	
Total Output Voltage Range	46.80		49.20	V	Over sample, line, load, temperature & life
Output Voltage Ripple and Noise					20 MHz bandwidth; see Note 1
Peak-to-Peak		180	360	mV	Full load
RMS		30	60	mV	Full load
Operating Output Current Range	0		5	A	Subject to thermal derating
Output DC Current Limit Inception	5.5	6.0	6.5	A	Output voltage 10 % Low
Output DC Current Limit Shutdown Voltage		27		V	
Back-Drive Current Limit while Enabled		0.1		A	Negative current drawn into output pins
Back-Drive Current Limit while Disabled		1		mA	Negative current drawn into output pins
Maximum Output Capacitance			100	µF	Vout nominal at full load (resistive load)
Output Voltage during Load Current Transient					
Step Change in Output Current (0.2 A/µs)		2700		mV	50 % to 75 % to 50 % Iout max; see Figure 5
Settling Time		400		µs	To within 1 % Vout nom; see Figure 5
Output Voltage Trim Range	-20		10	%	Across Pins 8 & 4; Common Figures 3-5
Output Voltage Remote Sense Range			10	%	Across Pins 8 & 4
Output Over-Voltage Protection	56.2	58.6	61.0	V	Over full temp range
EFFICIENCY					
100 % Load		90		%	See Figure 1 for efficiency curve
50 % Load		92		%	See Figure 1 for efficiency curve

Note 1: Output is terminated with 1 µF ceramic and 15 µF low-ESR tantalum capacitors. For applications requiring reduced output voltage ripple and noise, consult SynQor applications support (e-mail: support@synqor.com)

Note 3: Safety certification requires the use of a fuse rated at or below this value.

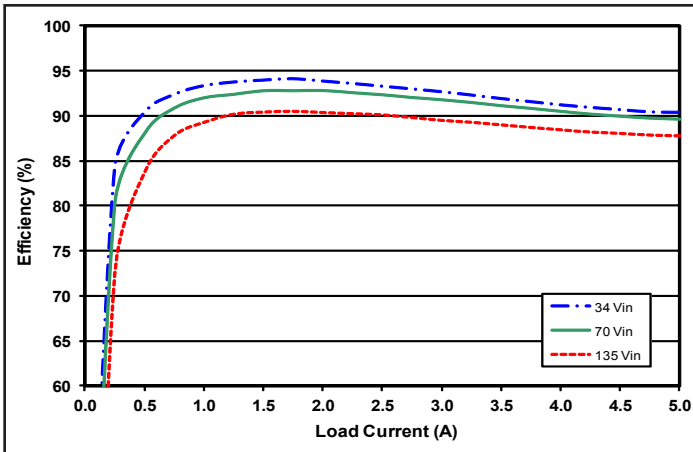

Figure 1: Efficiency at nominal output voltage vs. load current for minimum, nominal, and maximum input voltage at 25 °C.

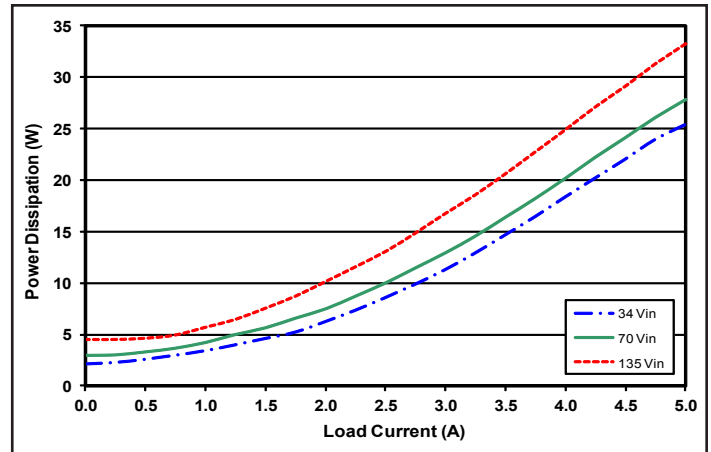

Figure 2: Power dissipation at nominal output voltage vs. load current for minimum, nominal, and maximum input voltage at 25 °C.

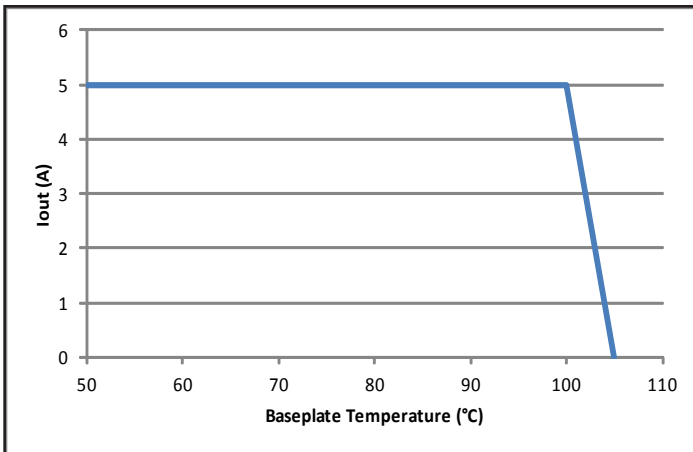

Figure 3: Maximum load current vs. baseplate temperature when conductively cooled. Note: The system design must provide a suitable thermal path that maintains the baseplate temperature below 100 °C.

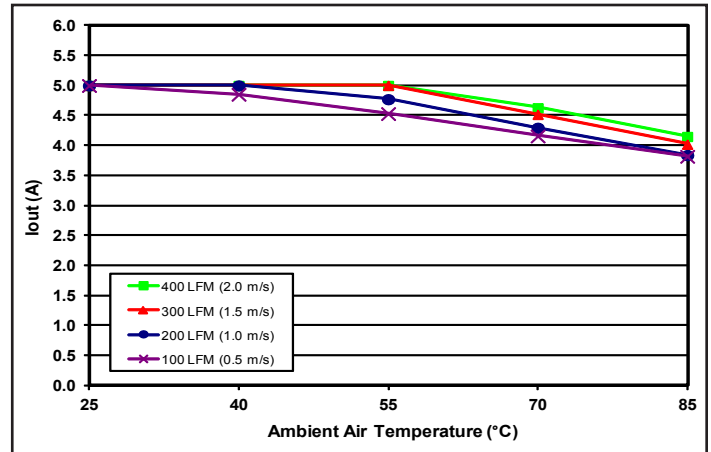

Figure 4: Encased converter (with 1/2" heatsink) max. output power derating vs. ambient air temperature for airflow rates of 100 LFM through 400 LFM. Air flows across the converter from input to output (nominal input voltage).

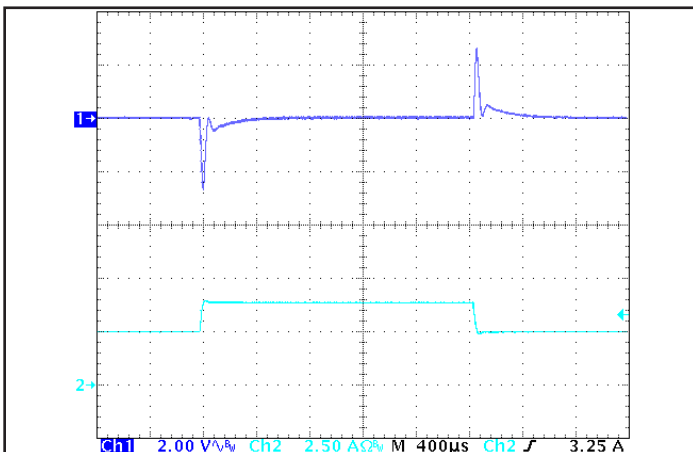

Figure 5: Output voltage response to step-change in load current (50% -75% -50% of I_{out}(max); dI/dt = 0.2 A/μs). Load cap: 1 μF ceramic capacitor. Ch 1: V_{out}, Ch 2: I_{out}.

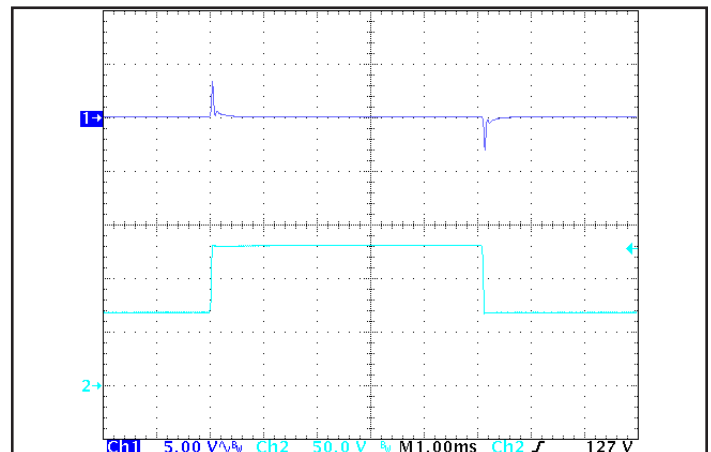

Figure 6: Output voltage response to step-change in input voltage (nominal to maximum, 250 V/ms). Load cap: 1 μF ceramic capacitor. Ch 1: V_{out}, Ch 2: V_{in}.

BASIC OPERATION AND FEATURES

This converter series uses a two-stage power conversion topology. The first stage is a buck-converter that keeps the output voltage constant over variations in line, load, and temperature. The second stage uses a transformer to provide the functions of input/output isolation and voltage step-up or step-down to achieve the output voltage required.

Both the first stage and the second stage switch at a fixed frequency for predictable EMI performance. Rectification of the transformer's output is accomplished with synchronous rectifiers. These devices, which are MOSFETs with a very low on-state resistance, dissipate far less energy than Schottky diodes. This is the primary reason that the converter has such high efficiency.

These converters are offered totally encased to withstand harsh environments and thermally demanding applications. Dissipation throughout the converter is so low that it does not require a heatsink for operation in many applications; however, adding a heatsink provides improved thermal derating performance in demanding applications.

This series of converters use the industry standard footprint and pin-out configuration.

CONTROL FEATURES

REMOTE ON/OFF (Pin 2): The ON/OFF input, Pin 2, permits the user to control when the converter is on or off. This input is referenced to the return terminal of the input bus, Vin(-). The ON/OFF signal is active low (meaning that a low turns the converter on). Figure A details four possible circuits for driving the ON/OFF pin. Figure B is a detailed look of the internal ON/OFF circuitry.

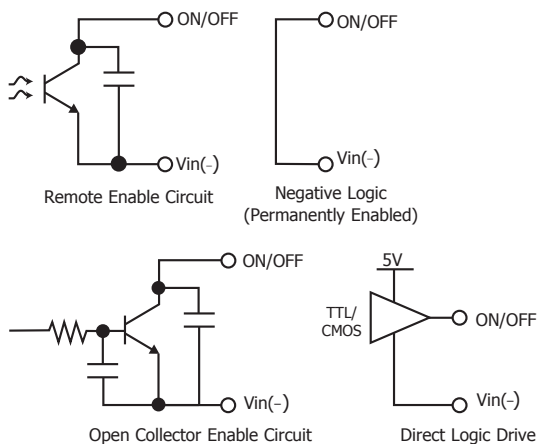

Figure A: Various circuits for driving the ON/OFF pin.

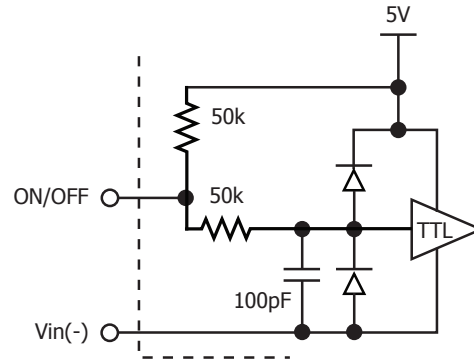

Figure B: Internal ON/OFF pin circuitry

REMOTE SENSE(±) (Pins 7 and 5): The SENSE(±) inputs correct for voltage drops along the conductors that connect the converter's output pins to the load.

Pin 7 should be connected to Vout(+) and Pin 5 should be connected to Vout(-) at the point on the load where regulation is desired. A remote connection at the load can adjust for a voltage drop only as large as that specified in this datasheet, that is

$$[V_{out(+)} - V_{out(-)}] - [V_{sense(+)} - V_{sense(-)}] \leq \text{Sense Range \%} \times V_{out}$$

$$\text{Sense Range \%} = \text{Trim-up Range \% (usually 10 \%)}$$

Pins 7 and 5 must be connected for proper regulation of the output voltage. If these connections are not made, the converter will deliver an output voltage that is slightly higher than its specified value.

Note: the output over-voltage protection circuit senses the voltage across the output (pins 8 and 4) to determine when it should trigger, not the voltage across the converter's sense leads (pins 7 and 5). Therefore, the resistive drop on the board should be small enough so that output OVP does not trigger, even during load transients.

OUTPUT VOLTAGE TRIM (Pin 6): The TRIM input permits the user to adjust the output voltage across the sense leads up or down according to the trim range specifications.

To decrease the output voltage, the user should connect a resistor between Pin 6 and Pin 5 (SENSE(-) input). For a desired decrease of the nominal output voltage, the value of the resistor should be

$$R_{\text{trim-down}} = \left(\frac{511}{\Delta\%} \right) - 10.22 \text{ [k}\Omega\text{]}$$

where

$$\Delta\% = \left| \frac{V_{\text{nominal}} - V_{\text{desired}}}{V_{\text{nominal}}} \right| \times 100[\%]$$

To increase the output voltage, the user should connect a resistor between Pin 6 and Pin 7 (SENSE(+) input). For a desired increase of the nominal output voltage, the value of the resistor should be

$$R_{\text{trim-up}} = \left(\frac{5.11V_{\text{OUT}} \times (100 + \Delta\%)}{1.225\Delta\%} - \frac{511}{\Delta\%} - 10.22 \right) \text{ [k}\Omega\text{]}$$

where V_{out} = Nominal Output Voltage

Trim graphs show the relationship between the trim resistor value $R_{\text{trim-up}}$ and $R_{\text{trim-down}}$, showing the total range the output voltage can be trimmed up or down.

Note: the TRIM feature does not affect the voltage at which the output over-voltage protection circuit is triggered. Trimming the output voltage too high may cause the over-voltage protection circuit to engage, particularly during transients.

It is not necessary for the user to add capacitance at the Trim pin. The node is internally bypassed to eliminate noise.

Total DC Variation of VOUT: For the converter to meet its full specifications, the maximum variation of the dc value of VOUT, due to both trimming and remote load voltage drops, should not be greater than that specified for the output voltage trim range.

PROTECTION FEATURES

Input Under-Voltage Lockout: The converter is designed to turn off when the input voltage is too low, helping avoid an input system instability problem, described in more detail in the application note titled "Input System Instability" on our website. The lockout circuitry is a comparator with dc hysteresis. When the input voltage is rising, it must exceed the typical Turn-On Voltage Threshold value (listed on the specifications page) before the converter will turn on. Once the converter is on, the input voltage must fall below the typical Turn-Off Voltage Threshold value before the converter will turn off.

Output Current Limit: The maximum current limit remains constant as the output voltage drops. However, once the output voltage drops below the specified Output DC Current-Limit Shutdown Voltage, the converter turns off.

The converter then enters a "hiccup mode" where it repeatedly turns on and off at a 5 Hz (nominal) frequency with a 5 % duty cycle until the overload is removed. This prevents excessive heating of the converter or the system board.

Output Over-Voltage Limit: If the voltage across the output pins exceeds the Output Over-Voltage Protection threshold, the converter will immediately stop switching. This prevents damage to the load circuit due to 1) excessive series resistance in output current path from converter output pins to sense point, 2) a release of an overload condition, or 3) a release of a current limit condition. Load capacitance determines exactly how high the output voltage will rise in response to these conditions. After 200 ms the converter will automatically restart.

Over-Temperature Shutdown: A temperature sensor on the internal converter PCB senses the average temperature of the module. The thermal shutdown circuit is designed to turn the converter off when the temperature at the sensed location reaches the Over-Temperature Shutdown value. It will allow the converter to turn on again when the temperature of the sensed location falls by the amount of the Over-Temperature Shutdown Restart Hysteresis value.

APPLICATION CONSIDERATIONS

Input System Instability: This condition can occur because any dc-dc converter appears incrementally as a negative resistance load. A detailed application note titled "Input System Instability" is available on the SynQor website which provides an understanding of why this instability arises, and shows the preferred solution for correcting it. The Electrical Characteristics Table indicates a "Recommended External Input Capacitance". The value needed for that capacitance and ESR can vary based on application parameters. Input stability can be evaluated using our "Stability Calculator" tool in the Technical Support section of our website www.synqor.com.

Application Circuits: Figure C provides a typical circuit diagram which details the input filtering and voltage trimming.

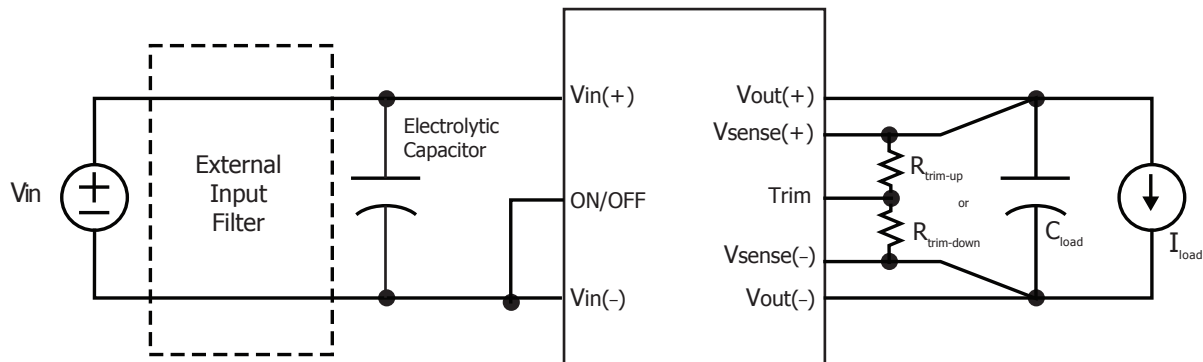

Figure C: Typical application circuit (negative logic unit, permanently enabled).

Input Filtering and External Capacitance: Figure D provides a diagram showing the internal input filter components. This filter dramatically reduces input terminal ripple current, which otherwise could exceed the rating of an external electrolytic input capacitor. The recommended external input capacitance is specified in the

Input Characteristics section on the Electrical Characteristics page. The input capacitance need not exactly match the specified value. More detailed information is available in the application note titled "EMI Characteristics" on the SynQor website.

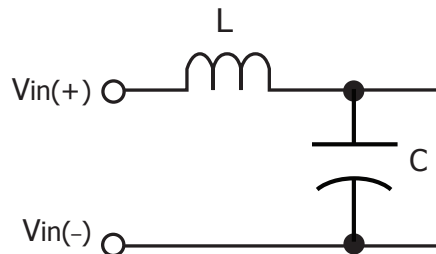

Figure D: Internal Input Filter Diagram (component values listed on the input characteristics page).

Startup Inhibit Period: The Startup Inhibit Period ensures that the converter will remain off for approximately 200 ms when it is shut down for any reason. When an output short is present, this generates a 5 Hz "hiccup mode," which prevents the converter from overheating. In all, there are seven ways that the converter can be shut down, initiating a Startup Inhibit Period:

- Input Under-Voltage Lockout
- Input Over-Voltage Shutdown
- Output Over-Voltage Protection
- Over Temperature Shutdown
- Current Limit (when Vout is below shutdown voltage)
- Short Circuit Protection
- Turned off by the ON/OFF input

Figure E shows three turn-on scenarios, where a Startup Inhibit Period is initiated at t_0 , t_1 , and t_2 :

Before time t_0 , when the input voltage is below the UVL threshold, the unit is disabled by the Input Under-Voltage Lockout (UVL) feature. When the input voltage rises above the UVL threshold, the Input Under-Voltage Lockout is released, and a Startup Inhibit Period is initiated. At the end of this delay, the ON/OFF pin is evaluated, and since it is active, the unit turns on.

At time t_1 , the unit is disabled by the ON/OFF pin, and it cannot be enabled again until the Startup Inhibit Period has elapsed.

When the ON/OFF pin goes low after t_2 , and the Startup Inhibit Period has elapsed, and the output turns on within the typical Turn-On Time.

Thermal Considerations: The maximum operating baseplate temperature, T_B , is 100 °C. As long as the user's thermal system keeps $T_B \leq 100$ °C, the converter can deliver its full rated power.

A power derating curve can be calculated for any heatsink that is attached to the baseplate of the converter. It is only necessary to determine the thermal resistance, R_{THBA} , of the chosen heatsink between the baseplate and the ambient air for a given airflow rate. This information is available from the heatsink vendor. The following formula can then be used to determine the maximum power the converter can dissipate for a given thermal condition if its baseplate is to be no higher than 100 °C.

$$P_{diss}^{max} = \frac{100 \text{ °C} - T_A}{R_{THBA}}$$

This value of power dissipation can then be used in conjunction with the data shown in Figure 2 to determine the maximum load current (and power) that the converter can deliver in the given thermal condition.

We recommend that a suitable thermal interface material such as a thermally conductive pad or grease be used to assure a good thermal interface between the base plate and the conductive cooling device.

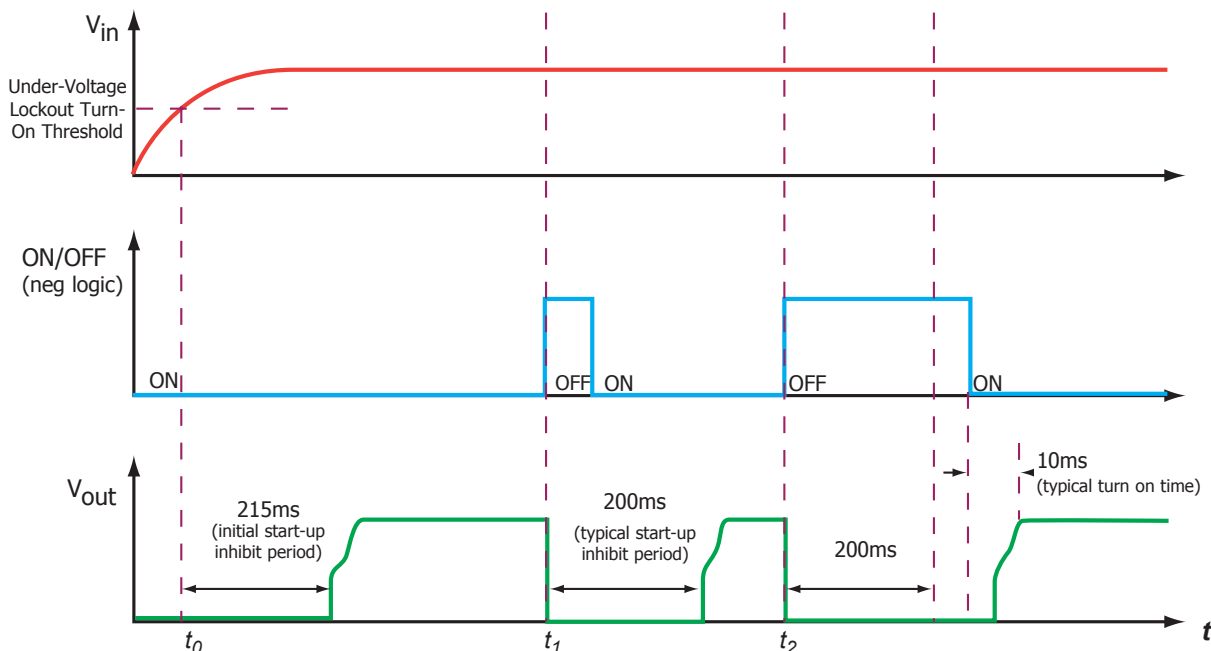

Figure E: Startup Inhibit Period (turn-on time not to scale)

Standards & Qualification Testing

Parameter	Notes & Conditions
STANDARDS COMPLIANCE	
UL 60950-1	Reinforced Insulation
CAN/CSA C22.2 No. 60950-1	
EN 60950-1	
CE Marked	2006/95/EC Low Voltage Directive

Note: An external input fuse must always be used to meet these safety requirements. Contact SynQor for official safety certificates on new releases or download from the SynQor website.

Parameter	# Units	Test Conditions
QUALIFICATION TESTING		
Life Test	32	95% rated Vin and load, units at derating point, 1000 hours
Vibration	5	10-55 Hz sweep, 0.060 " total excursion, 1 min./sweep, 120 sweeps for 3 axis
Mechanical Shock	5	100 g minimum, 2 drops in x, y, and z axis
Temperature Cycling	10	-40 °C to 100 °C, unit temp. ramp 15 °C/min., 500 cycles
Power/Thermal Cycling	5	Toperating = min to max, Vin = min to max, full load, 100 cycles
Design Marginality	5	Tmin-10 °C to Tmax+10 °C, 5 °C steps, Vin = min to max, 0-105% load
Humidity	5	85 °C, 95% RH, 1000 hours, continuous Vin applied except 5 min/day
Solderability	15 pins	MIL-STD-883, method 2003
Altitude	2	70,000 feet (21 km), see Note

Note: A conductive cooling design is generally needed for high altitude applications because of naturally poor convective cooling at rare atmospheres.

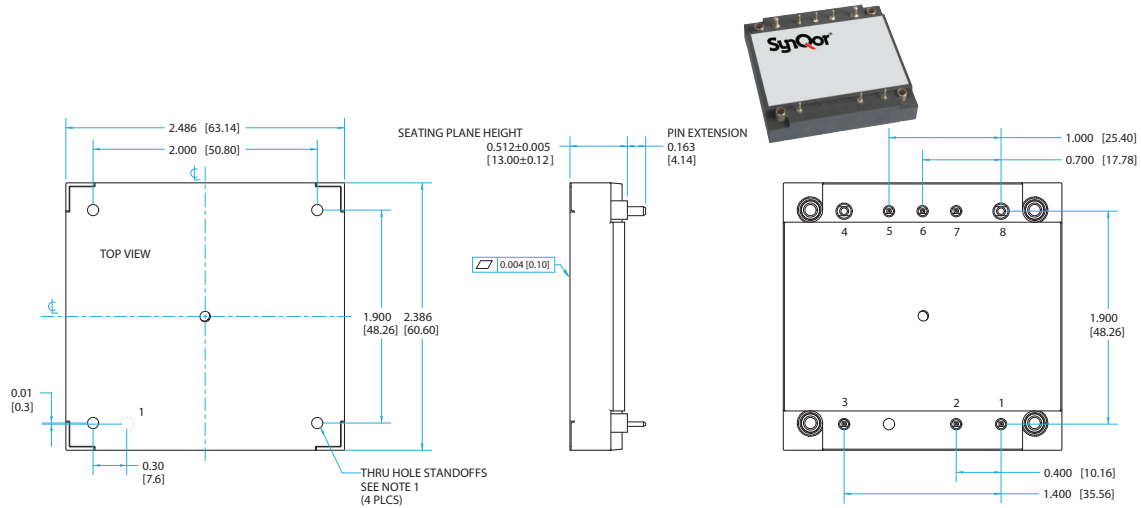

NOTES

- 1) THREADED: APPLIED TORQUE PER M3 SCREW 6 in-lb RECOMMENDED
NONTHREADED: DIA 0.125" (3.18 mm)
- 2) BASEPLATE FLATNESS TOLERANCE IS 0.004" (.10 mm)
TIR FOR SURFACE.
- 3) PINS 1-3 AND 5-7 ARE 0.040" (1.02 mm) DIA. WITH 0.080" (2.03
DIA. STANDOFFS.
- 4) PINS 4 AND 8 ARE 0.080" (2.03 mm) DIA. WITH 0.125" (3.18 mm)
DIA STANDOFFS
- 5) ALL PINS: MATERIAL: COPPER ALLOY
FINISH: MATTE TIN OVER NICKEL PLATE
- 6) WEIGHT: 4.7 oz (133 g)
- 7) ALL DIMENSIONS IN INCHES(mm)
TOLERANCES: X.XX IN +/-0.02 (X.X mm +/-0.5 mm)
X.XXX IN +/-0.010 (X.XX mm +/-0.25 mm)

PIN DESIGNATIONS

Label	Name	Function	
1	+VIN	Vin(+)	Positive Supply Input
2	ON/OFF	ON/OFF	TTL input to turn converter on and off, referenced to Vin(-), with internal pull up.
3	-VIN	Vin(-)	Negative Input Voltage
4	-VOUT	Vout(-)	Negative Output Voltage
5	-SNS	SENSE(-)	Negative Remote Sense (See Note 1)
6	TRIM	TRIM	Output Voltage Trim (See Note 2)
7	+SNS	SENSE(+)	Positive Remote Sense (See Note 3)
8	+VOUT	Vout(+)	Positive Output Voltage

Notes:

- 1) SENSE(-) should be connected to Vout(-) either remotely or at the converter
- 2) Leave TRIM pin open for nominal output voltage
- 3) SENSE(+) should be connected to Vout(+) either remotely or at the converter.

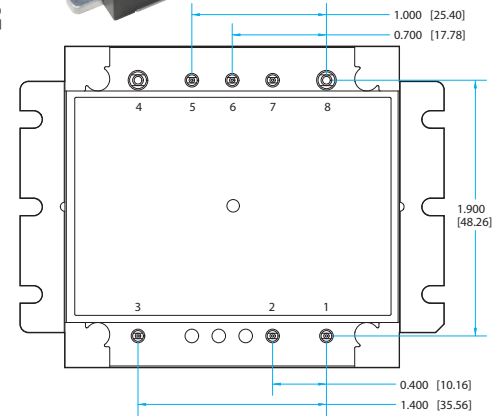
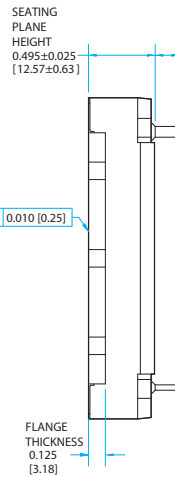
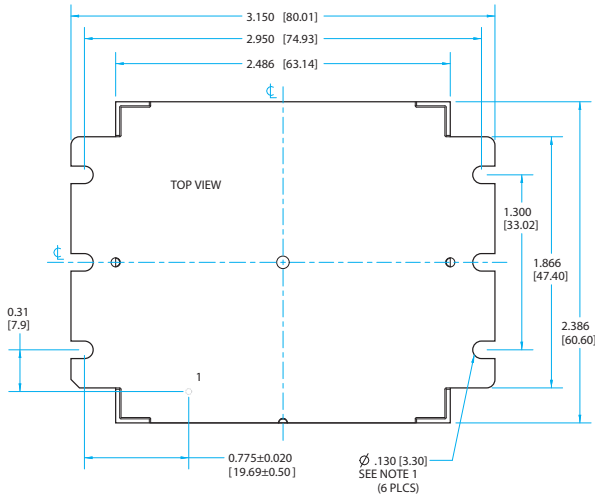
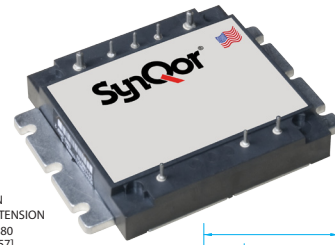

- 1) APPLIED TORQUE PER M3 OR 4-40 SCREW 6 in-lb RECOMMENDED
- 2) BASEPLATE FLATNESS TOLERANCE IS 0.010" (.25 mm) TIR FOR SURFACE.
- 3) PINS 1-3 and 5-7 ARE 0.040" (1.02 mm) DIA. WITH 0.080" (2.03 mm) DIA. STANDOFFS.
- 4) PINS 4 AND 8 ARE 0.080" (2.03 mm) DIA. WITH 0.125" (3.18 mm) DIA STANDOFFS
- 5) ALL PINS: MATERIAL: COPPER ALLOY
FINISH: MATTE TIN OVER NICKEL PLATE
- 6) WEIGHT: 4.9 oz (139 g) TYPICAL
- 7) ALL DIMENSIONS IN INCHES(mm)
- 8) TOLERANCES: X.XX IN +/-0.02 (X.X mm +/-0.5 mm)
X.XXX IN +/-0.010 (X.XX mm +/-0.25 mm)

PIN DESIGNATIONS

Label	Name	Function	
1	+VIN	Vin(+)	Positive Supply Input
2	ON/OFF	ON/OFF	TTL input to turn converter on and off, referenced to Vin(-), with internal pull up.
3	-VIN	Vin(-)	Negative Input Voltage
4	-VOUT	Vout(-)	Negative Output Voltage
5	-SNS	SENSE(-)	Negative Remote Sense (See Note 1)
6	TRIM	TRIM	Output Voltage Trim (See Note 2)
7	+SNS	SENSE(+)	Positive Remote Sense (See Note 3)
8	+VOUT	Vout(+)	Positive Output Voltage

Notes:

- 1) SENSE(-) should be connected to Vout(-) either remotely or at the converter
- 2) Leave TRIM pin open for nominal output voltage
- 3) SENSE(+) should be connected to Vout(+) either remotely or at the converter.

PART NUMBERING SYSTEM

The part numbering system for SynQor's dc-dc converters follows the format shown in the example below.

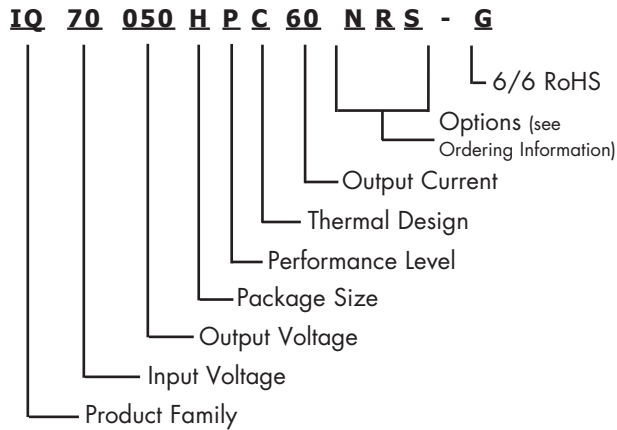

The first 12 characters comprise the base part number and the last 3 characters indicate available options. The "-G" suffix indicates 6/6 RoHS compliance.

Application Notes

A variety of application notes and technical white papers can be downloaded in pdf format from our [website](#).

RoHS Compliance: The EU led RoHS (Restriction of Hazardous Substances) Directive bans the use of Lead, Cadmium, Hexavalent Chromium, Mercury, Polybrominated Biphenyls (PBB), and Polybrominated Diphenyl Ether (PBDE) in Electrical and Electronic Equipment. This SynQor product is 6/6 RoHS compliant. For more information please refer to SynQor's RoHS addendum available at our [RoHS Compliance / Lead Free Initiative web page](#) or e-mail us at rohs@synqor.com.

ORDERING INFORMATION

The tables below show the valid model numbers and ordering options for converters in this product family. When ordering SynQor converters, please ensure that you use the complete 15 character part number consisting of the 12 character base part number and the additional characters for options. InQor units are only available with 6/6 RoHS compliance indicated by "-G".

Model Number	Input Voltage	Output Voltage	Max Output Current
IQ70050HPx44NRS	34-135 V	5 V	44 A
IQ70120HPx20NRS	34-135 V	12 V	20 A
IQ70150HPx16NRS	34-135 V	15 V	16 A
IQ70240HPx10NRS	34-135 V	24 V	10 A
IQ70280HPx8FNRS	34-135 V	28 V	8.5 A
IQ70480HPx05NRS	34-135 V	48 V	5 A

The following options must be included in place of the **wxyz** spaces in the model numbers listed above.

Options Description			
Thermal Design w	Enable Logic x	Pin Style y	Feature Set z
C - Encased D - Encased with Non-Threaded Baseplate V - Encased with Flanged Baseplate	N - Negative	R - 0.180"	S - Standard

Not all combinations make valid part numbers, please contact SynQor for availability.

Contact SynQor for further information and to order:

Phone: 978-849-0600 Toll Free: 888-567-9596 Fax: 978-849-0602

E-mail: power@synqor.com Web: www.synqor.com

Address: 155 Swanson Road, Boxborough, MA 01719 USA

Warranty

SynQor offers a two (2) year limited warranty. Complete warranty information is listed on our website or is available upon request from SynQor.

PATENTS

SynQor holds numerous U.S. patents, one or more of which apply to most of its power conversion products. Any that apply to the product(s) listed in this document are identified by markings on the product(s) or on internal components of the product(s) in accordance with U.S. patent laws. SynQor's patents include the following:

7,050,309 7,765,687 7,787,261
8,149,597 8,644,027